

Full HD Multiple Streams Vandal Proof Fixed Dome IP Camera

User Manual

User Name: **Admin**

Password: **1234**

Ver1.3

Table of Contents

1. Overview	2
1.1 Features	2
1.2 Package Contents	3
1.3 Dimensions.....	5
1.4 Connectors	6
2. Camera Cabling.....	7
2.1 Connect Power	7
2.2 Connect Ethernet Cable	7
2.3 Connect Alarm I/O.....	7
3. System Requirements	8
4. Access Camera	9
5. Setup Video Resolution.....	13
6. Configuration Files Export/ Import.....	17
Appendix A: Technical Specifications.....	18
Appendix B: Delete the Existing DC Viewer	21
Appendix C: Setup Internet Security	22

Log to **NUUO** as "Santec" :

SNC-3302 or SNC-4302 or SNC-5312IR or SNC-6032 or SNC-6312IRH

1. Overview

Supported with both H.264 and MJPEG standard, the product series not only features in superior Full HD resolution for real-time streaming at 25/30 fps, but also supplies D1 720p real-time streaming. With more computing power, the IP Camera could provide more flexibility for users and system managers.







1.1 Features

- Progressive Scan CMOS Sensor
- Dual Streams, Full HD real-time + D1 real-time
- H.264 and MJPEG compression
- Remote Zoom & Focus (Motorized Lens; Optional)
- Motion Detection
- Privacy Masks
- WDR
- Smart Picture Quality/3DNR
- Tampering Alarm
- Day/Night (ICR)
- Micro SD support
- BNC analog output
- IR LED module (Optional)
- Weatherproof (IP66 International)
- Vandal Proof Dome Cover
- Sunshield & Outdoor Mounting Kit
- ONVIF Support

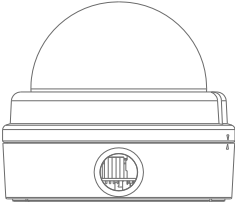



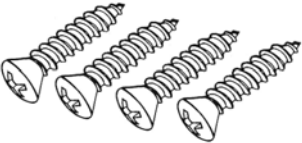
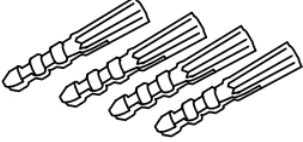

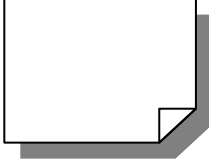

1.2 Package Contents

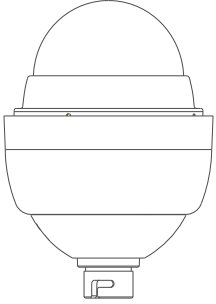
Please check the package contains the following items listed below.

Indoor Camera Package Contents

 <p>Vandal Proof Fixed Dome IP Camera</p>	 <p>DC Jack Cable</p>	
 <p>Power Terminal Block</p>	 <p>Security Torx</p>	
 <p>Self Tapping Screws (x4)</p>	 <p>Plastic Screw Anchors (x4)</p>	 <p>Rubber Washers (x6)</p>
 <p>CD (bundled software and documentation)</p>	 <p>Quick Guide</p>	

Outdoor Camera Package Contents

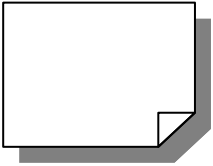
 <p>Vandal Proof Fixed Dome IP Camera</p>	 <p>DC Jack Cable</p>	
 <p>Power Terminal Block</p>	 <p>Security Torx</p>	 <p>Hexagon Screw-M8*12 (x1)</p>
 <p>Spring Washer (x1)</p>	 <p>Rubber Washer (x1)</p>	 <p>Pendant Tube Washer (x1)</p>
 <p>CD (bundled software and documentation)</p>	 <p>Quick Guide</p>	

1.3 Dimensions

The IP Dome Camera's dimensions are shown below.

Indoor

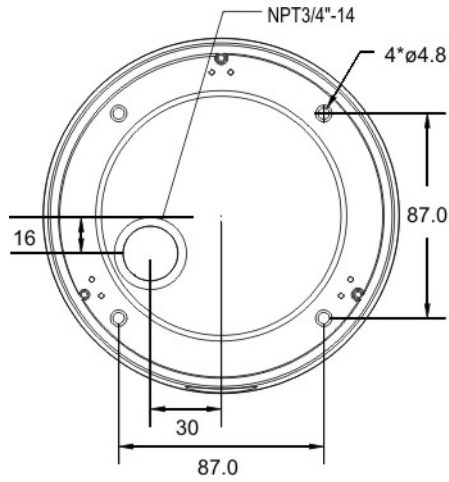

Top View

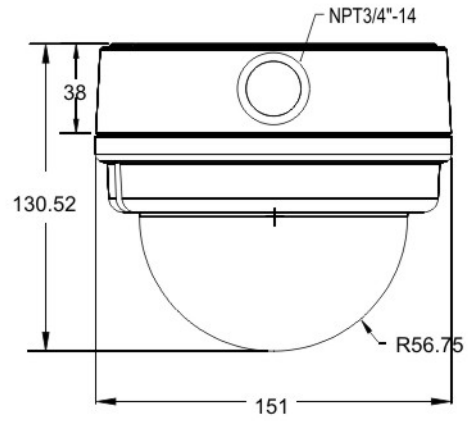

Side View

Unit: mm

Outdoor

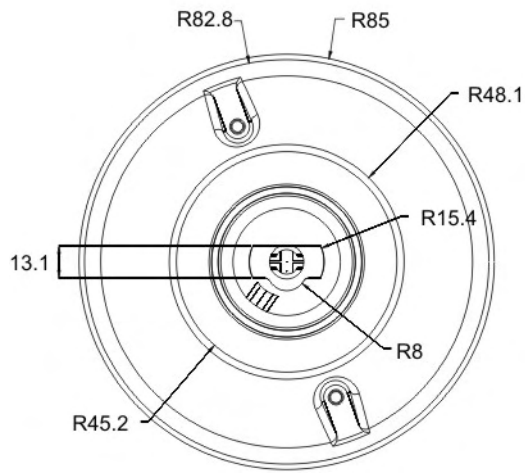

Top View

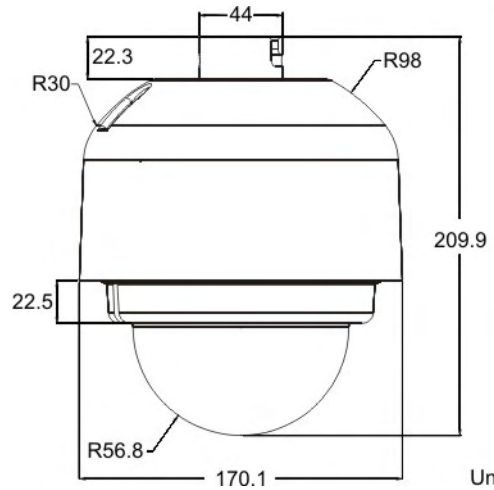

Side View

Unit: mm

1.4 Connectors

The diagram below shows the IP Camera's reset button and various connectors. Definition for each connector will be given as follows.

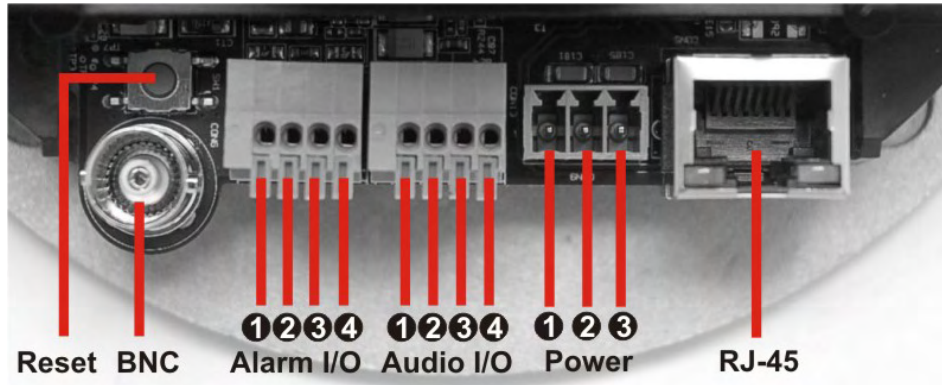

Connector		Pin No.	Definition	Remarks
Reset Button		-	Restore to factory default	
BNC		-	Analog Video Output	
Alarm I/O		1	GND (Input-)	Alarm connection
		2	Input+	
		3	Output-	
		4	Output+	
Audio I/O		1	Output (L)	Two-way audio transmission
		2	Output (R)	
		3	GND	
		4	Input	
Power	DC 12V	1	Power	Power connection
		2	Reserved	
		3	GND	
	AC 24V	1	Power-1	
		2	Earth GND	
		3	Power-2	
RJ-45		-	10/100 Mbps Ethernet / PoE	

2. Camera Cabling

Please follow the instructions below to complete IP Camera connection.

2.1 Connect Power

Please refer to [Section: Connectors](#). Alternatively, connect the Ethernet cable to the camera's PoE port and plug the other end of the cable into a PoE switch.



NOTE: If using PoE, make sure Power Sourcing Equipment (PSE) is in use in the network.

2.2 Connect Ethernet Cable

Use of Category 5 Ethernet cable is recommended for network connection; to have best transmission quality, cable length shall not exceed 100 meters. Connect one end of the Ethernet cable to the RJ-45 connector of the IP Dome Camera, and the other end of the cable to the network switch or PC.



NOTE: In some cases, you may need use an Ethernet crossover cable when connecting the IP Dome Camera directly to the PC.

Check the status of the link indicator and activity indicator LEDs; if the LEDs are unlit, please check LAN connection.

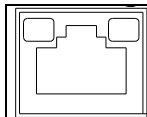

Green Link Light indicates good network connection.
Orange Activity Light flashes for network activity indication.

2.3 Connect Alarm I/O

The camera equips one alarm input and one relay output for alarm application. Refer to alarm pin definition below to connect alarm devices to the IP Camera if needed.

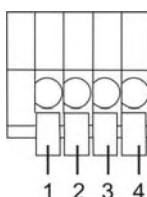

PIN 1: GND (Input-)
PIN 2: Input+
PIN 3: Output-
PIN 4: Output+

3. System Requirements

To perform the IP Camera via web browser, please ensure your PC is in good network connection, and meet system requirements as described below.

Items	System Requirement
Personal Computer	1. Intel® Pentium® M, 2.16 GHz or Intel® Core™2 Duo, 2.0 GHz 2. 2 GB RAM or more
Operating System	Windows VISTA / Windows XP / Windows 7
Web Browser	Microsoft Internet Explorer 6.0 or later Firefox Chrome Safari
Network Card	10Base-T (10 Mbps) or 100Base-TX (100 Mbps) operation
Viewer	ActiveX control plug-in for Microsoft IE

4. Access Camera

For initial access to the IP Camera, users can search the camera through the installer program: DeviceSearch.exe, which can be found in “DeviceSearch” folder in the supplied CD.

Device Search Software Setup

Step 1: Double click on the program Device Search.exe. After its window appears, click on the <Device Search> button on the top side.

Step 2: The security alert window will pop up. Click on <Unblock> to continue.

Device Search

Step 3: Click on <Device Search> again, and all the finding IP devices will be listed in the page. The IP Camera’s default IP address is: **192.168.0.250**.

Step 4: Double click or right click and select <Browse> to access the camera directly via web browser.

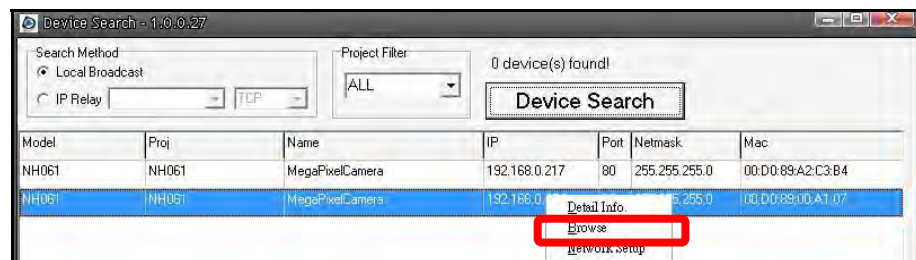

Step 5: Then the prompt window of request for entering default username and password will appear for login to the IP Dome Camera.

The default login ID and password for the Administrator are:

Login ID	Password
Admin	1234



NOTE: ID and password are case sensitive.



NOTE: It is strongly advised that administrator’s password be altered for the security concerns. Refer to [Full HD Multiple Streams IP Camera Menu Tree](#) for further details.

Additionally, users can change the IP Camera's network property, either DHCP or Static IP directly in the device finding list. Refer to the following section for changing the IP Camera's network property.

Example of Changing IP Camera's Network Property

Users can directly change an IP Camera's network property, ex. from static IP to DHCP, in the finding device list. The way to change the IP Camera's network property is specified below:

Step 1: In the finding device list, click on the IP Camera that you would like to change its network property. On the selected item, right click and select "Network Setup." Meanwhile, record the IP Camera's MAC address, for future identification.

Step 2: The "Network Setup" page will come out. Select "DHCP," and press "Apply" button down the page.

Step 3: Click on <OK> on the Note of setting change. Wait for one minute to re-search the IP Camera.

Step 4: Click on the <Device Search> button to re-search all the devices. Then select the IP Camera with the correct MAC address. Double click on the IP Camera, and the login window will come out.

Step 5: Enter User name and Password to access the IP Camera.

Installing DC Viewer Software Online

For the initial access to the IP Camera, a client program, DC Viewer, will be automatically installed to your PC when connecting to the IP Camera.

If the Web browser doesn't allow DC Viewer installation, please check the Internet security settings or ActiveX controls and plug-ins settings (refer to [Section: Internet Security Settings](#)) to continue the process.

The Information Bar (just below the URL bar) may come out and ask for permission to install the ActiveX Control for displaying video in browser. Right click on the Information Bar and select <Install ActiveX Control...> to allow the installation.

The download procedure of DC Viewer software is specified as follows.

Step 1: In the DC Viewer installation window, click on <Next> to start installation.

Step 2: The status bar will show the installation progress. After the installation is completed, click on <Finish> to exit the installation process.

Step 3: Click on <Finish> to close the DC Viewer installation page.

Once the DC Viewer is successfully installed, the IP Camera's Home page will be able to correctly display as the figure below.

Vari-focal Model

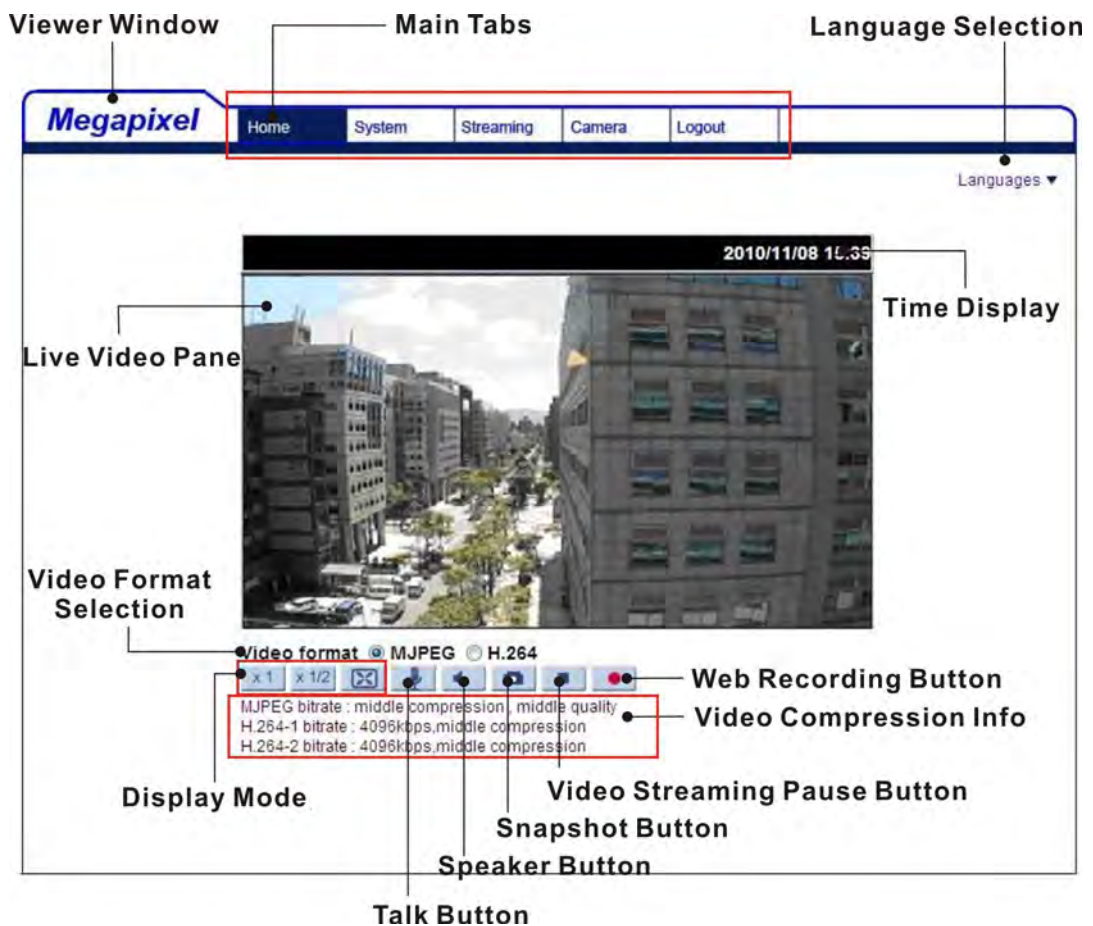

Motorized Model

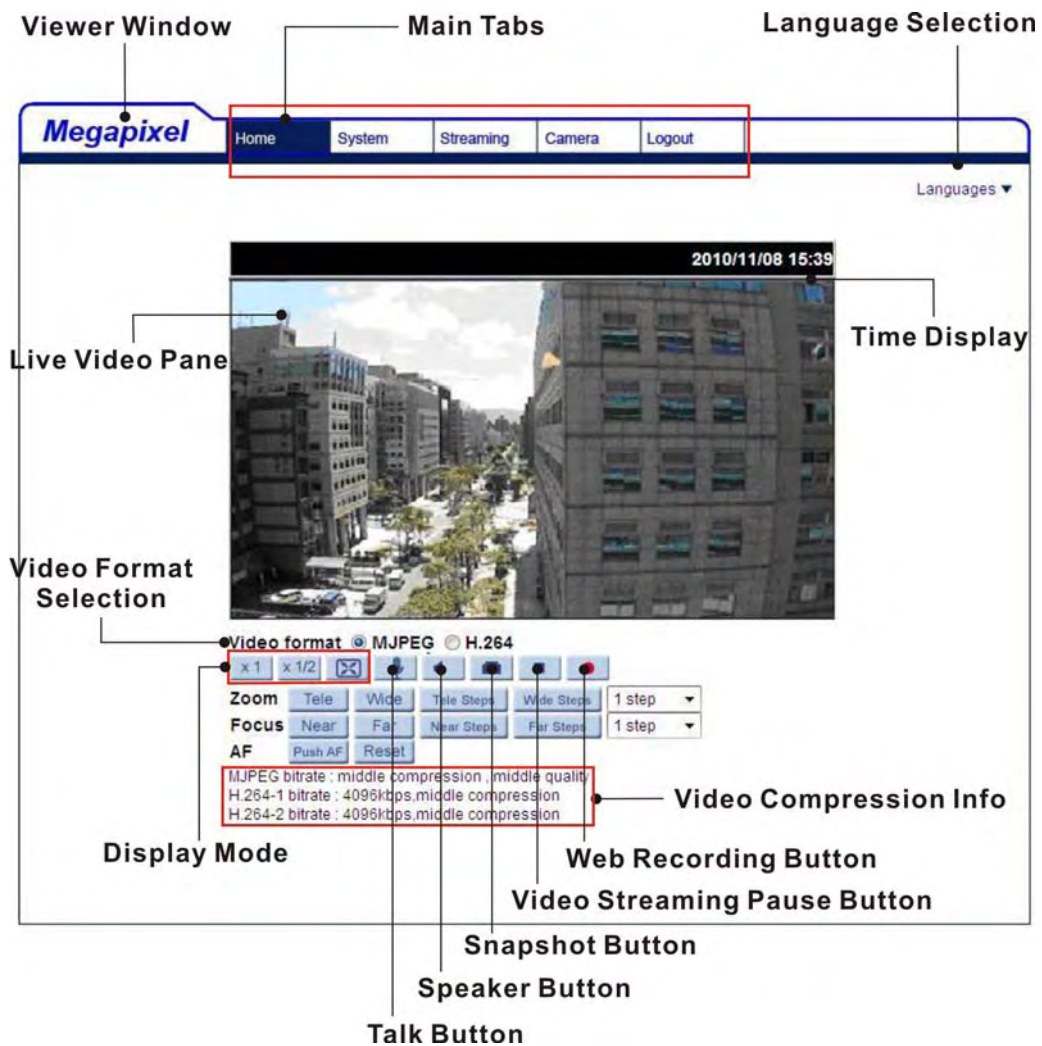

Image and Focus Adjustment

The image displays on the Home page when successfully accessing to the IP Camera. Adjust zoom and focus as necessary to produce a clear image.



Note: Please refer to [Full HD Multiple Streams IP Camera Menu Tree](#) for more button function detail.

5. Setup Video Resolution

Users can setup Video Resolution on Video Format page of the user-friendly browser-based configuration interface.

Video Format can be found under this path: **Streaming> Video Format**.

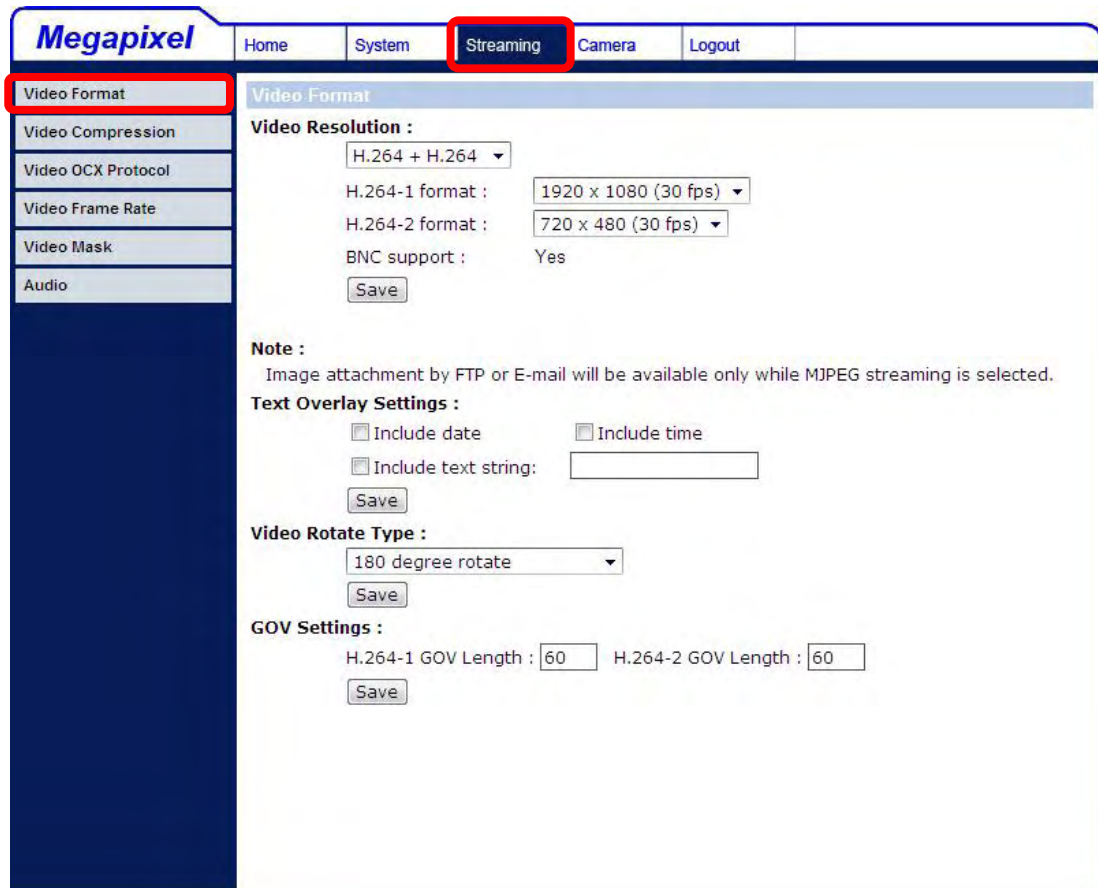

The screenshot displays the Megapixel configuration interface. The top navigation bar includes 'Home', 'System', 'Streaming', 'Camera', and 'Logout'. The 'Streaming' menu item is highlighted with a red box. On the left sidebar, the 'Video Format' menu item is also highlighted with a red box. The main content area is titled 'Video Format' and contains the following sections:

- Video Resolution :**
 - H.264 + H.264 (dropdown)
 - H.264-1 format : 1920 x 1080 (30 fps) (dropdown)
 - H.264-2 format : 720 x 480 (30 fps) (dropdown)
 - BNC support : Yes
 - Save button
- Note :**

Image attachment by FTP or E-mail will be available only while MJPEG streaming is selected.
- Text Overlay Settings :**
 - Include date
 - Include time
 - Include text string: [text input field]
 - Save button
- Video Rotate Type :**
 - 180 degree rotate (dropdown)
 - Save button
- GOV Settings :**
 - H.264-1 GOV Length : [60] H.264-2 GOV Length : [60]
 - Save button

Video Format

Under Video Resolution section, select a preferred resolution setting. The available Video Resolution for MJPEG & H.264 format includes:

H.264 + H.264		
H.264-1	H.264-2	BNC SUPPORT
1920 x 1080 (30fps)	720 x 480 (30fps)*	√
	640 x 480 (30fps)	√
	352 x 240 (30fps)	√
1920 x 1080 (15fps)	1920 x 1080 (15fps)	√
	1280 x 1024 (30fps)	√
	1280 x 720 (30fps)	√
	1024 x 768 (30fps)	√
	800 x 600 (30fps)	-
	720 x 480 (30fps)	√
	640 x 480 (30fps)	√
1280 x 1024 (30fps)	352 x 240 (30fps)	√
	1280 x 1024 (15fps)	√
	1280 x 720 (30fps)	-
	1024 x 768 (30fps)	-
	800 x 600 (30fps)	-
	720 x 480 (30fps)	√
	640 x 480 (30fps)	√
1280 x 720 (30fps)	352 x 240 (30fps)	√
	1280 x 720 (30fps)	√
	1024 x 768 (30fps)	-
	800 x 600 (30fps)	-
	720 x 480 (30fps)	√
	640 x 480 (30fps)	√
1024 x 768 (30fps)	352 x 240 (30fps)	√
	1024 x 768 (30fps)	√
	800 x 600 (30fps)	-
	720 x 480 (30fps)	√
	640 x 480 (30fps)	√
	352 x 240 (30fps)	√

800 x 600 (30fps)	800 x 600 (30fps)	√
	720 x 480 (30fps)	√
	640 x 480 (30fps)	√
	352 x 240 (30fps)	√
720 x 480 (30fps)	720 x 480 (30fps)	√
	640 x 480 (30fps)	√
	352 x 240 (30fps)	√
640 x 480 (30fps)	640 x 480 (30fps)	√
	352 x 240 (30fps)	√
352 x 240 (30fps)	352 x 240 (30fps)	-
H.264 + MJPEG		
H.264	MJPEG	BNC SUPPORT
1920 x 1080 (30fps)	720 x 480 (30fps)	√
	640 x 480 (30fps)	√
	352 x 240 (30fps)	√
1920 x 1080 (15fps)	1920 x 1080 (15fps)	√
	1280 x 1024 (30fps)	√
	1280 x 720 (30fps)	√
	1024 x 768 (30fps)	√
	800 x 600 (30fps)	-
	720 x 480 (30fps)	√
	640 x 480 (30fps)	√
	352 x 240 (30fps)	√
1280 x 1024 (30fps)	1280 x 1024 (15fps)	√
	1280 x 720 (30fps)	-
	1024 x 768 (30fps)	-
	800 x 600 (30fps)	-
	720 x 480 (30fps)	√
	640 x 480 (30fps)	√
	352 x 240 (30fps)	√
1280 x 720 (30fps)	1280 x 720 (30fps)	√
	1024 x 768 (30fps)	-
	800 x 600 (30fps)	-
	720 x 480 (30fps)	√
	640 x 480 (30fps)	√
	352 x 240 (30fps)	√

1024 x 768 (30fps)	1024 x 768 (30fps)	√
	800 x 600 (30fps)	-
	720 x 480 (30fps)	√
	640 x 480 (30fps)	√
	352 x 240 (30fps)	√
800 x 600 (30fps)	800 x 600 (30fps)	√
	720 x 480 (30fps)	√
	640 x 480 (30fps)	√
	352 x 240 (30fps)	√
720 x 480 (30fps)	720 x 480 (30fps)	√
	640 x 480 (30fps)	√
	352 x 240 (30fps)	√
640 x 480 (30fps)	640 x 480 (30fps)	√
	352 x 240 (30fps)	√
352 x 240 (30fps)	352 x 240 (30fps)	-
MJPEG Only		
MJPEG		BNC SUPPORT
1920 x 1080 (30fps)		√
1280 x 1024 (30fps)		√
1280 x 720 (30fps)		√
1024 x 768 (30fps)		√
800 x 600 (30fps)		√
720 x 480 (30fps)		√
640 x 480 (30fps)		√
352 x 240 (30fps)		-
H.264 Only		
H.264		BNC SUPPORT
1920 x 1080 (30fps)		√
1280 x 1024 (30fps)		√
1280 x 720 (30fps)		√
1024 x 768 (30fps)		√
800 x 600 (30fps)		√
720 x 480 (30fps)		√
640 x 480 (30fps)		√
352 x 240 (30fps)		-

(*) Default

Click on <Save> to confirm the setting.

6. Configuration Files Export/ Import

To export/ import configuration files, users can access the Maintenance page on the user-friendly browser-based configuration interface.

The Maintenance setting can be found under this path: **System> Maintenance**.

Users can export configuration files to a specified location and retrieve data by uploading an existing configuration file to the IP Camera. It is especially convenient to make multiple cameras having the same configuration.

Export

Users can save the system settings by exporting the configuration file (.bin) to a specified location for future use. Click on the <Export> button, and the popup File Download window will come out. Click on <Save> and specify a desired location for saving the configuration file.

Upload

To copy an existing configuration file to the IP Camera, please first click on <Browse> to select the configuration file, and then click on the <Upload> button for uploading.

Appendix A: Technical Specifications

Camera		Full HD Multiple Streams Vandal Proof Fixed Dome IP Camera
Image Sensor		1/2.7" Progressive CMOS
Effective Pixels		1920(H) x 1080(V)
Minimum Illumination	Color	0.2 lux
	B/W	0.02 lux
Shutter Speed		1~ 1/10000 sec.
White Balance		Manual / AWB/ ATW
Lens		
Lens Type	Vari-focal/ Motorized lens	F1.2/ f =3-9 mm
FOV (16:9 resolution)		103.5(W) ~ 34.3(T)
Operation		
Video Compression		H.264/ MJPEG
Video Streaming		Simultaneous H.264 1080p (25/30 fps) + MJPEG D1 (25/30 fps)
		Simultaneous H.264 1080p (25/30 fps) + H.264 D1 (25/30 fps)
Resolution	H.264	Full HD 1080p/ SXGA/ HD 720p/ XGA/ SVGA/ D1/ VGA/ CIF
	MJPEG	
Image Setting	Brightness	Manual
	Exposure	Auto / Manual
	Sharpness	Manual
	Contrast	Manual
	White Balance	Auto / Manual
	Saturation	Manual
	Hue	Manual
	Backlight Compensation	On/Off
	Digital Zoom	Support
	WDR	On/Off
	3D Noise Reduction	On/Off
	Motion detection	On/Off
	Privacy Mask	On/Off
	Privacy Mask Type	Color
	ICR *	Auto/ On/ Off
Tampering Alarm	On/Off	
Audio	Two-way Audio	Line out, Line in/ mic in

	Compression	G.711/G.726
Alarm	Input	5V 10k Ω pull up
	Output	Photo Relay Output 300V DC/AC
Event Notification		HTTP, FTP, SMTP
Multiple Languages		English, French, German, Italian, Simplified Chinese, Russian, Korean
Network		
Interface		10/100Mbps Ethernet (RJ-45)
Protocol		IPv4/ v6, TCP/IP, UDP, RTP, RTSP, HTTP, HTTPS, ICMP,FTP, SMTP, DHCP, PPPoE, UPnP, IGMP, SNMP, QoS, and ONVIF
Password Levels		User and Administrator
Security		HTTPS, IP Filter, IEEE 802.1X
Internet Browser		Internet Explorer (6.0+), Chrome, Firefox, Safari
User Account		20
Mechanical		
Built-in IR Illuminator*	Working distance	Up to 25m
	Wavelength	850nm
	Number of LEDs	24
Connectors	Power	3 pins terminal block
	Ethernet	RJ-45
	Micro SD	Micro SDHC 32GB support
	Audio	4 pins terminal block
	Alarm In/ Out	4 pins terminal block
	Analog Video	1.0 Vp-p / 75 Ω , BNC
LED Indicator		Power, Link, ACT
General		
Operating Temperature		-10°C ~ 50°C (14°F ~122°F)
		w/Heater & Fan, powered by DC12V/AC24V: -35°C ~ 50°C (-31° ~ 122° F) Humidity: 10% to 90%, no condensation
Power Source		DC12V/ AC24V/ PoE
Power Consumption		System: 5W (Heater: +6W, Fan: +1W, Built-in IR Illuminator: +3W, Motorized Lens: +3.6W)
Weatherproof Standard		IP66
Regulatory		CE, FCC, RoHS Compliant
Dimension	Indoor	\varnothing 151 x 130 mm (\varnothing 5.9 x 5.1 inches)
	Outdoor	\varnothing 170 x 210 mm (\varnothing 6.7 x 8.3 inches)

Weight	Indoor	0.8 kg (1.8 lbs)
	Outdoor	1.3 kg (2.9 lbs)

(*) Optional

Note: Motorized Lens will be available in Q4 2011

Appendix B: Delete the Existing DC Viewer

For users who have installed the DC Viewer in the PC previously, please first remove the existing DC Viewer from the PC before accessing to the IP Camera.

Deleting the DC Viewer

In the Windows <Start Menu>, activate <Control Panel>, and then double click on <Add or Remove Programs>. In the <Currently installed programs> list, select <DCViewer> and click on the button <Remove> to uninstall the existing DC Viewer.

Deleting Temporary Internet Files

To improve browser performance, it is suggested to clean up the all the files in the Temporary Internet Files.

The procedure is as follows:

Step 1: Click on the <Tools> tab on the menu bar and select <Internet Options>.

Step 2: Click on the <Delete> button under <Browsing history> section. Then click on the <Delete Files> button under the <Temporary Internet files> section.

Step 3: A confirmation window will pop up. Click on <Yes> to start deleting the files.

Appendix C: Setup Internet Security

If ActiveX control installation is blocked, please either set Internet security level to default or change ActiveX controls and plug-ins settings.

Internet Security Level: Default

Step 1: Start the Internet Explorer (IE).

Step 2: Click on the <Tools> tab on the menu bar and select <Internet Options>.

Step 3: Click on the <Security> tab, and select <Internet> zone.

Step 4: Down the page, click on the <Default Level> button and click on <OK> to confirm the setting. Close the browser window, and restart a new one later to access the IP Camera.

ActiveX Controls and Plug-ins Settings

Step 1: Repeat **Steps 1~3** of the previous section above.

Step 2: Down the page, click on the <Custom Level> button to change ActiveX controls and plug-ins settings. The Security Settings window will pop up.

Step 3: Under <ActiveX controls and plug-ins>, set **ALL** items (as listed below) to <Enable> or <Prompt>. Please note that the items vary by IE version.

ActiveX controls and plug-ins settings:

1. Allow previously unused ActiveX controls to run without prompt.
2. Allow Scriptlets.
3. Automatic prompting for ActiveX controls.
4. Binary and script behaviors.
5. Display video and animation on a webpage that does not use external media player.
6. Download signed ActiveX controls.
7. Download unsigned ActiveX controls.
8. Initialize and script ActiveX controls not marked as safe for scripting.
9. Run ActiveX controls and plug-ins.
10. Script ActiveX controls marked safe for scripting.

Step 4: Click on <OK> to accept the settings and close the Security Settings window.

Step 5: Click on <OK> to close the Internet Options screen.

Step 6: Close the browser window, and restart a new one later to access the IP Camera.